



PART-77

CAA Consolidation

Objects and Activities Affecting Navigable Airspace

DESCRIPTION

Part 77 prescribes rules for persons proposing to construct or alter a structure that could pose a hazard in navigable airspace.

Part 77 also prescribes rules regarding the use of a structure, lights, lasers, weapons, or pyrotechnics that could pose a hazard in navigable airspace.

This document is the current consolidated version of Part 77 produced by the Civil Aviation Authority, and serves as a reference only. It is compiled from the official ordinary rules that have been signed into law by the Minister of Road and Transport Development. Copies of the official rule and amendments as signed by the Minister may be obtained from the Civil Aviation Authority or may be downloaded from the official web site at: www.mcaa.gov.mn

Bulletin

Subject to “Memorandum for Technical Cooperation” between the CAA of Mongolia and New Zealand on mutual cooperation in implementation of Assembly Resolution A29-3: Global Rule Harmonization, 29th ICAO Assembly, 1992, which urges States to promote global harmonization of national rules, dated 6th of May, 1999, Mongolian Civil Aviation Safety Regulation has been developed.

Amendment history	Effective Date
Original issue	01 May.2003
Amendment 1	07 May.2010
Amendment 2 (Re-issue)	012017

Note: This Part 77 re-issue has been released in English and Mongolian languages, based on NZCAR Part 77 Amend.4.

List of Rules

77.1	Purpose	5
77.3	Definitions	5
77.5	Notice of construction or alteration of structure.....	6
77.7	Notice of use of a structure discharging efflux, a light, or a laser.....	6
77.9	Notice of use of weapons.....	7
77.11	Notice of use of pyrotechnics.....	7
77.13	Notice requirements.....	7
77.15	Additional notice requirements.....	8
77.17	Aeronautical study	8
77.19	Standards for determining hazards.....	9
77.21	Determinations.....	10
77.23	Compliance.....	11
77.25	Determination effective dates and periods.....	11
77.27	Petitions for review of determinations of hazard	11
77.29	Petition for review or extension of determinations of no hazard.....	12
Appendix A — Obstacle Notification Surfaces		14
Appendix B — Visual Aids for denoting obstacles		15
B.1	Obstacles.....	15
B.2	Obstacles to be marked or lighted	15
B.3	General.....	16
B.4	Use of colours.....	16
B.5	Use of markers	17
B.6	Use of flags.....	18
B.7	Use of obstacle lights.....	18
B.8	Location of obstacle lights.....	19
B.9	Low-intensity obstacle light characteristics	21
B.10	Medium-intensity obstacle light characteristics	22
B.11	High-intensity obstacle light characteristics	22
Appendix C — Shielding		23

77.1 Purpose

(a) Subject to paragraph (b), this Part prescribes rules for persons within the territorial limits of Mongolia including the Mongolian Defence Force, proposing—

- (1) to construct or alter a structure that could constitute a hazard in navigable airspace; or
- (2) the use of a structure, lights, lasers, weapons, or pyrotechnics, that could constitute a hazard in navigable airspace.

(b) This Part does not apply to—

- (1) any member of the Mongolian Defence Force or any aircraft operated by the Mongolian Defence Force acting in connection with—
 - (i) any war or other like emergency; or
 - (ii) the defence of Mongolia and other Mongolia interests; or
 - (iii) aid to the civil power in time of emergency; or
 - (iv) the provision of any public service; or
 - (v) any operation performed within a restricted, danger, or military operating area designated under Part 71 for military purposes; and
- (2) activities to which Part 101 applies.

77.3 Definitions

In this Part—

Ground level at its site means the highest ground within a 600 m radius of the site:

ICAO document 8168–OPS/611 means the procedures for air navigation services and aircraft operations, approved and published by decision of the Council of the International Civil Aviation Organisation:

Navigable airspace means airspace at or above the minimum flight altitudes prescribed by or under the Civil Aviation Rules, including all legitimate low level operations but not including restricted, danger, and military operations areas activated for use by the Mongolian Defence Force:

Obstacle limitation surface means airspace defined around an aerodrome that enables operations at the aerodrome to be conducted safely and that prevents the aerodrome from becoming unusable by the growth of obstacles around the aerodrome:

77.5 Notice of construction or alteration of structure

A person proposing to construct or alter a structure must notify the Director of the proposal in accordance with rule 77.13 if the proposed structure or alteration to a structure—

- (1) extends more than 60 m in height above the ground level at its site; or
- (2) exceeds the general tree height in the area by 18 m and is located in an area of low level aerial activity or other low flying activity, or in a low flying zone or low level route as prescribed under Part 71; or
- (3) is located below the approach or take-off surfaces of an aerodrome as outlined in figures A.1 and A.2 of Appendix A, and extends to a height greater than a surface, outlined in Appendix A, extending outward and upward at 1 of the following:
 - (i) a slope of 1:83 from the fan origin of the takeoff surface of a runway where the runway is used or intended to be used by aircraft with a MCTOW above 5700 kg;
 - (ii) a slope of 1:50 from the fan origin of the takeoff surface of a runway where the runway is used or intended to be used by aircraft with a MCTOW at or below 5700 kg;
 - (iii) a slope of 1:25 from the nearest point of the safety area of a heliport; or
- (4) penetrates the conical, inner horizontal, or transitional side surface of an aerodrome as—
 - (i) outlined in figure A.1 of Appendix A; or
 - (ii) specified in Part 139; or
 - (iii) as defined in the local district scheme.

77.7 Notice of use of a structure discharging efflux, a light, or a laser

(a) A person proposing to use a structure must notify the Director of the proposal in accordance with rule 77.13 if—

- (1) the structure may discharge efflux at a velocity in excess of 4.3 m per second through an obstacle limitation surface of an aerodrome; or
- (2) the structure may discharge efflux at a velocity in excess of 4.3 m per second higher than 60 m above ground level.

(b) A person proposing to operate a light or a laser must notify the Director in accordance with rule 77.13 if—

- (1) because of its glare or affect on a pilot's vision, the light or laser is liable to endanger aircraft; or

- (2) for a laser, it would produce exposures in exceeding the maximum permissible exposure defined for that laser in S/AS 2211; or
- (3) it is likely to endanger aircraft by being mistaken for—
 - (i) a light or part of a system of lights established or approved for display at or near an aerodrome; or
 - (ii) a light marking a hazard in navigable airspace.

77.9 Notice of use of weapons

A person, or a person representing an organisation, must notify the Director in accordance with rule 77.13 if the person or organisation proposes to use a weapon that fires or launches a projectile that has a trajectory higher than—

- (1) 45 m if within 4 km of an aerodrome boundary; or
- (2) 120 m if more than 4 km from an aerodrome boundary.

77.11 Notice of use of pyrotechnics

(a) A person must notify the Director in accordance with rule 77.13 if the person proposes to stage a pyrotechnics display that involves the firing or launching of a projectile that has a trajectory higher than—

- (1) 45 m if within 4 km of an aerodrome boundary; or
- (2) 120 m if more than 4 km from an aerodrome boundary.

77.13 Notice requirements

(a) Subject to paragraphs (b) and (c), a person required to notify the Director under rules 77.5, 77.7, 77.9, or 77.11 must complete form CAA 24077/01 and submit it to the Director at least—

- (1) 90 days before the proposed date of commencement of construction, or alteration, under rule 77.5; or
- (2) 5 working days before the proposed date of use under rules 77.7, 77.9, or 77.11.

(b) In the case of an emergency involving essential public services, public health, or public safety, that requires immediate construction or alteration of a structure, or use of a structure, light, laser, weapon, or pyrotechnic—

- (1) the notice requirements in paragraph (a) do not apply; and
- (2) the person responsible for the construction, alteration, or use must complete form CAA 24077/01 and submit it to the Director within 5 working days after the construction, alteration, or use.

- (c) A person proposing to use a light, laser, weapon, or pyrotechnic, in a control zone prescribed under Part 71 during times when the appropriate ATS is on watch—
- (1) is not required to provide notice under paragraph (a); and
 - (2) must not use the light, laser, weapon, or pyrotechnic in the control zone without prior authorisation from the ATC unit responsible for that airspace which must be given at least 5 working days before the commencement of the use.

77.15 Additional notice requirements

- (a) A person who is required to notify the Director under rules 77.5 and 77.7 must, if required by the Director, notify the Director in writing of the actual commencement date of the construction, alteration, or use, as applicable.
- (b) A person who is required to notify the Director under rule 77.5 regarding the construction or alteration of a structure must notify the Director in writing within 5 working days when the structure has reached its greatest height.
- (c) The notice required by paragraph (b) when the structure reaches its greatest height must include a registered surveyor's determination of the height and position of the structure, and proof of compliance with any marking and lighting requirements imposed by the Director under rule 77.21(d).
- (d) A person who abandons a project to construct or alter a structure that is the subject of a notice under rule 77.5 must notify the Director in writing within 5 working days after the project is abandoned.
- (e) A person who dismantles a structure or is responsible for a structure that is destroyed must, if the structure met the criteria for notification under rule 77.5, notify the Director in writing of the dismantling or destruction of the structure within 5 working days after the structure is dismantled or destroyed.

77.17 Aeronautical study

- (a) On receiving a notification under 77.5, 77.7, 77.9, or 77.11 the Director shall conduct an aeronautical study to determine whether the specific proposal, if executed, will constitute a hazard in navigable airspace.
- (b) In conducting the aeronautical study, the Director shall consult with such persons, industry representatives, representative groups, and organisations as the Director considers appropriate.

77.19 Standards for determining hazards

- (a) The Director must determine a structure to be a hazard in navigable airspace if it is 120 m or higher above ground level at its site.
- (b) The Director must determine the use of a structure to be a hazard in navigable airspace if the structure will or may discharge efflux at a velocity in excess of 4.3 m per second through the obstacle limitation surfaces applicable to an aerodrome.
- (c) The Director must determine the use of a structure to be a hazard in navigable airspace if the structure will or may discharge efflux at a velocity in excess of 4.3 m per second higher than 120 m above ground level.
- (d) The Director must determine the use of a light to be a hazard in navigable airspace if an analysis discloses that its use will constitute a hazard in navigable airspace.
- (e) The Director may determine, based on the circumstances of each proposal, the use of a laser to be a hazard in navigable airspace if its use will produce exposures in navigable airspace exceeding the maximum permissible exposure defined for that laser in S/AS 2211.
- (f) The Director must determine the use of a weapon to be a hazard in navigable airspace if an analysis discloses that its use will constitute a hazard in navigable airspace.
- (g) The Director must determine the use of pyrotechnics to be a hazard in navigable airspace if an analysis discloses that their use will constitute a hazard in navigable airspace.
- (h) The Director may determine, based on the circumstances of each proposal, a structure to be a hazard in navigable airspace if—
- (1) it is located within an instrument flight procedures area that is specified in ICAO document 8168–OPS/611, including standard arrival routes, initial, intermediate, final, visual and missed approach segment areas, departure areas and standard instrument departure routes, and would result in—
 - (i) the vertical distance between any point on the structure and an established minimum instrument flight altitude within that area or segment being less than obstacle clearance required for the instrument flight procedure; or
 - (ii) additional or new ceiling or visibility restrictions or a change in flight procedures applicable to departures within that area; or

- (2) it is located within an IFR en-route obstacle clearance area, including evaluated routes on Mongolian en-route and area charts but excluding charted routes as published in the AIP Mongolia, and would necessitate an increase in an existing or planned minimum obstacle clearance altitude; or
- (3) it exceeds the general tree height by 18 m and is located in an area of low level aerial activity or other low flying activity, or in a low flying zone or low level route as prescribed under Part 71; or
- (4) it protrudes through the obstacle limitation surfaces of an aerodrome.

77.21 Determinations

(a) The Director shall, within 28 working days of receiving any notification under 77.13(a) for construction, alteration, or use of a structure, make a determination as to whether the proposed construction, alteration, or use, if executed, will be a hazard in navigable airspace and shall advise the notifier and any other person the Director considers could be affected by the determination.

(b) The Director shall, within 10 working days of receiving any notification under 77.13(a) for use of lights, lasers, weapons, or pyrotechnics, make a determination as to whether the proposed use, if executed, will be a hazard in navigable airspace and shall advise the notifier and any other person the Director considers could be affected by the determination.

(c) The Director shall, within 4 working days of receiving any notification under 77.13(c), make a determination as to whether the proposed use of lights, lasers, weapons, or pyrotechnics, if executed, will be a hazard in navigable airspace and shall advise the notifier and any other person the Director considers could be affected by the determination.

(d) The Director shall base each determination upon the aeronautical study findings and may—

- (1) impose any conditions or limitations—
 - (i) for marking or lighting a structure as outlined in Appendix B; and
 - (ii) that ensure the hazard in navigable airspace is minimised; and
 - (iii) in determinations of no hazard in navigable airspace, considered necessary to minimise potential problems, such as the use of temporary construction equipment; and
- (2) specify additional notice requirements.

77.23 Compliance

Each person required by 77.5, 77.7, 77.9, or 77.11 to provide notice to the Director shall comply with any requirement, condition, or limitation imposed under 77.21(d).

77.25 Determination effective dates and periods

- (a) A determination regarding a proposed—
- (1) construction, alteration, or use of a structure notified under rule 77.13(a) becomes final 28 days after the date the determination is made under rule 77.21(a), unless a petition for review is received by the Director under rule 77.27(b); and
 - (2) use of lights, lasers, weapons, or pyrotechnics notified under rule 77.13(a) becomes final 5 working days before the proposed date of use indicated to the Director on form CAA 24077/01, unless a petition for review is received by the Director under rule 77.27(b).
- (b) Unless reviewed or extended under rule 77.29, a final determination of no hazard in navigable airspace made under this Part—
- (1) in respect of construction, alteration, or use of a structure, expires 18 months after the determination becomes final, or on the date the proposed construction, alteration, or use is abandoned, whichever is earlier; and
 - (2) in respect of use of lights, lasers, weapons, or pyrotechnics, expires upon completion of use as indicated to the Director on form CAA 24077/01, or on the date the proposed use is abandoned, whichever is earlier.
- (c) A determination of hazard that has become final—
- (1) under rule 77.25(a)(1) or rule 77.27(f)(2), regarding construction, alteration, or use of a structure, does not expire but may be revoked in writing by the Director; and
 - (2) under rule 77.25(a)(2) or rule 77.27(f)(2), regarding use of lights, lasers, weapons, or pyrotechnics, expires upon completion of use as indicated on form CAA 24077/01 or the day after the date of use granted as extended by the Director.

77.27 Petitions for review of determinations of hazard

- (a) Each person proposing the construction or alteration of a structure, or use of a structure, lights, lasers, weapons, or pyrotechnics, may petition the Director for a review of a determination of hazard made by the Director.
- (b) Each petition for a review of a determination shall be submitted in writing, to be received by the Director prior to a determination becoming final under 77.25(a), and shall—

- (1) contain a full statement of the aeronautical basis upon which the petition is made; and
 - (2) present new information or facts not previously considered or discussed during the aeronautical study, including valid aeronautical reasons why the determination, revision, or extension made by the Director shall be reviewed; and
 - (3) identify and explain the basis of the petition, if the petition for a review is based upon an error in reasoning, interpretation of procedures, application of hazard standards, or assumptions of fact.
- (c) A determination shall not become final until any petition for review filed in accordance with paragraph (b) has been dealt with by the Director.
- (d) The Director shall examine each petition, submitted in accordance with paragraph (b), and decide whether a review will be granted.
- (e) If a review is granted the Director shall—
- (1) inform the petitioner of the issues to be studied and reviewed if different to the issues presented in the petition or the determination; and
 - (2) take no longer to complete the review than was taken to make the determination under 77.21(a), (b), or (c) as applicable.
- (f) If the Director determines that a review is denied—
- (1) the petitioner shall be notified of the basis for the decision; and
 - (2) the determination shall become final at the time the review is denied or as prescribed under 77.25(a), whichever is the later.

77.29 Petition for review or extension of determinations of no hazard

- (a) Any person may petition the Director, in the case of a determination of no hazard in navigable airspace under this Part, to review the determination based on new facts that change the basis upon which it was made, or to extend the effective period of determination, if—
- (1) where applicable, the proposed construction or alteration of a structure has not started by actual structural work, such as the laying of a foundation, but not including excavation; and
 - (2) the petition is submitted at least 30 days before the expiration date of the final determination of no hazard in navigable airspace.
- (b) The Director, having made the determination of no hazard in navigable airspace, shall examine each petition presented and review the determination, or extend or affirm the original expiry date of the determination.

- (c) A final determination of no hazard in navigable airspace expiring—
 - (1) under 77.25(b)(1) may be extended by the Director for periods of not more than six months at a time; and
 - (2) under 77.25(b)(2) may be extended by the Director for periods of not more than 14 days at a time.

Appendix A — Obstacle Notification Surfaces

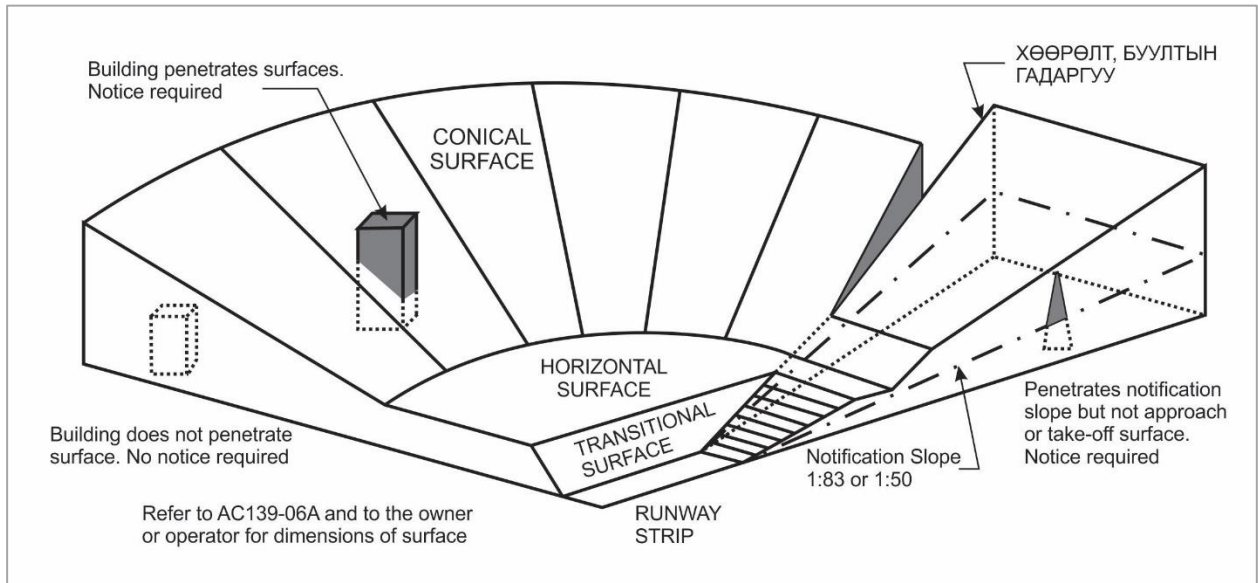

Figure A.1 – Aerodrome Notification Requirements

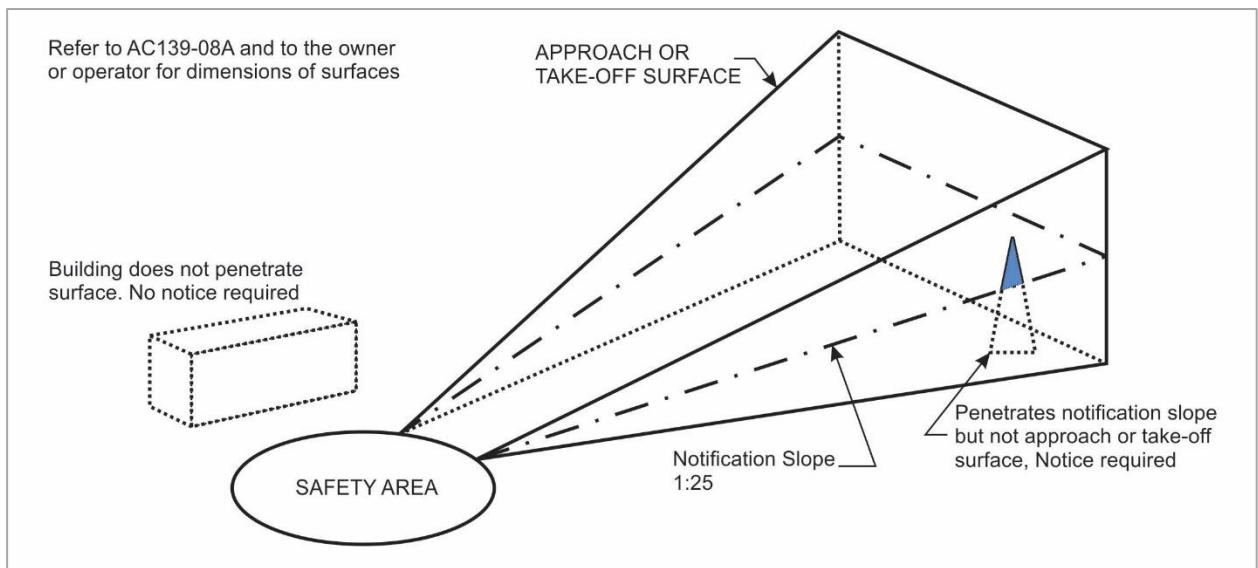

Figure A.2 – Heliport Notification Requirements

Appendix B — Visual Aids for denoting obstacles

B.1 Obstacles

For the purpose of this Appendix the term obstacle is used to refer to those objects that the Director has determined to be a hazard under 77.21.

B.2 Obstacles to be marked or lighted

(a) A fixed obstacle that extends above the obstacle limitation surfaces required by Part 139 shall be marked and, if the aerodrome is used at night, lighted, except that—

- (1) the marking may be omitted when the obstacle is lighted by high-intensity obstacle lights by day; and
- (2) the lighting may be omitted where the obstacle is a lighthouse and an aeronautical study indicates the lighthouse light to be sufficient; and
- (3) such marking or lighting may be omitted when—
 - (i) the obstacle is shielded by another fixed obstacle already marked or lighted; or
 - (ii) for a circuit extensively obstructed by immovable objects or terrain, procedures have been established to ensure safe vertical clearance below prescribed flight paths; or
 - (iii) an aeronautical study shows the obstacle not to be of operational significance.

(b) A fixed obstacle that meets or exceeds any of the standards for determining hazards under 77.19, not included in paragraph (a), shall be marked or lighted except that—

- (1) the marking may be omitted when the obstacle is lighted by high-intensity obstacle lights by day; and
- (2) the lighting may be omitted where the obstacle is a lighthouse and an aeronautical study indicates the lighthouse light to be sufficient; and
- (3) the marking or lighting may be omitted when—
 - (i) the obstacle is shielded by another fixed obstacle already marked or lighted; or
 - (ii) an aeronautical study shows the obstacle not to be of operational significance.

B.3 General

All fixed obstacles to be marked shall be coloured, but if this is impracticable, markers or flags shall be displayed on or above them, except that the obstacles that are sufficiently conspicuous by their shape, size, or colour need not be otherwise marked.

B.4 Use of colours

(a) An obstacle, if its projection on any vertical plane has both dimensions less than 1500 mm, shall be marked by a single conspicuous colour being orange or red, unless those colours merge with the background.

(b) An obstacle, if it has essentially unbroken surfaces and its projection on any vertical plane equals or exceeds 4500 mm in both dimensions, shall be marked by—

- (1) orange and white, or red and white, except where such colours merge with the background; and
- (2) a chequered pattern of squares of not less than 1500 mm and not more than 3000 mm on a side, the corners being of the darker colour. See figure B.1.

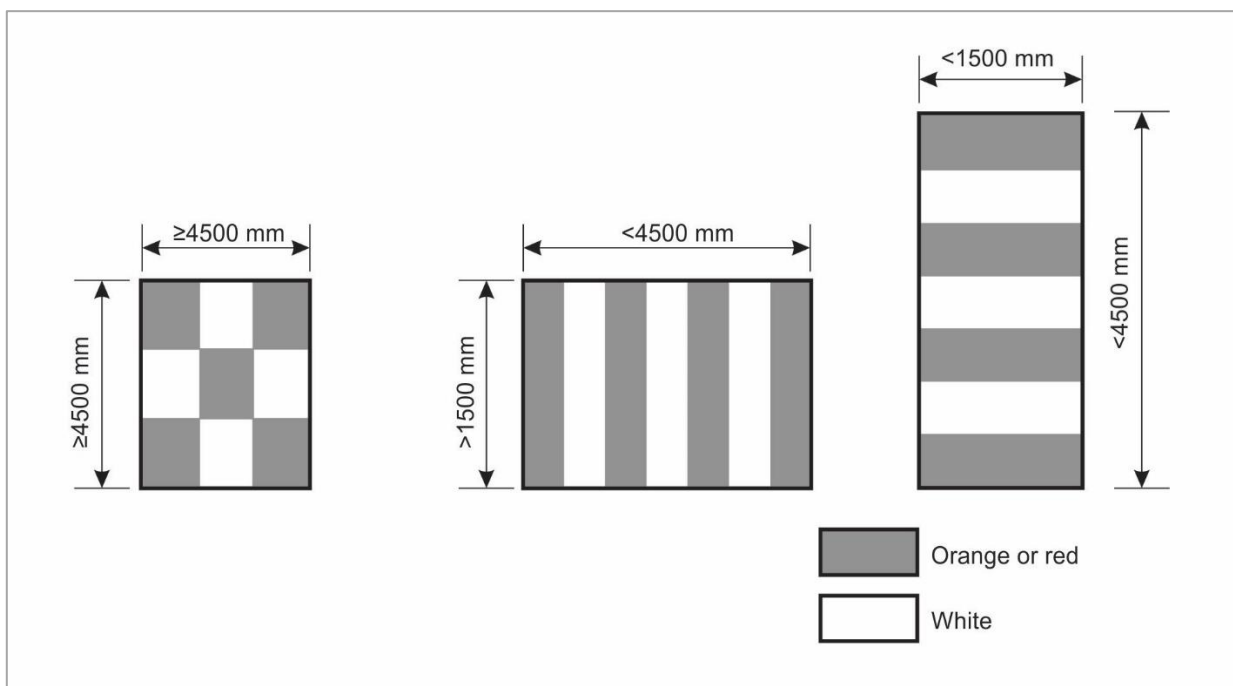

Figure B.1 – Basic marking patterns

(c) An obstacle shall be marked by alternating contrasting coloured bands if—

- (1) it has essentially unbroken surfaces and has one dimension, horizontal or vertical, greater than 1500 mm, and the other dimension, horizontal or vertical, less than 4500 mm; or
- (2) it is of skeletal type with either a vertical or a horizontal dimension greater than 1500 mm. See figure B.1.

(d) The bands referred to in paragraph (c) shall—

- (1) be perpendicular to the longest dimension; and

- (2) have a width approximately one seventh of the longest dimension or 30 m, whichever is less; and
 - (3) be coloured orange and white unless those colours are not conspicuous when viewed against the background; and
 - (4) be so placed that the bands on the extremities of the obstacle are of the darker colour.
- (e) Table B.1 shows a formula for determining band widths to ensure an odd number of bands, thus permitting the extreme bands to be of the darker colour. Also see Figure B.1.

Table B.1 – Band Widths

Longest dimension		Band width
Greater than	Not exceeding	
1.5 m	210 m	1/7 of longest dimension
210 m	270 m	1/9 of longest dimension
270 m	330 m	1/11 of longest dimension
330 m	390 m	1/13 of longest dimension
390 m	450 m	1/15 of longest dimension
450 m	510 m	1/17 of longest dimension
510 m	570 m	1/19 of longest dimension
570 m	630 m	1/21 of longest dimension

B.5 Use of markers

Markers displayed on or adjacent to obstacles shall—

- (1) be located in conspicuous positions so as to retain the general definition of the obstacle; and
- (2) be recognisable in all directions in which an aircraft is likely to approach the object, in clear weather, from a distance of at least—
 - (i) 1000 m for an obstacle to be viewed from the air; and
 - (ii) 300 m for an obstacle to be viewed from the ground; and
- (3) have a distinctive shape to the extent necessary to ensure they are not mistaken for markers employed to convey other information; and
- (4) be such that the hazard presented by the obstacle they mark is not increased.

B.6 Use of flags

- (a) Flags used to mark obstacles shall be—
 - (1) displayed around, on top of, or around the highest edge of, the object; and
 - (2) be such that the hazard presented by the obstacle they mark is not increased.
- (b) When flags are used to mark extensive obstacles or groups of closely spaced obstacles, they shall be displayed at least every 15 m.
- (c) Flags used to mark fixed obstacles shall—
 - (1) not be less than 600 mm by 600 mm; and
 - (2) be orange in colour or a combination of two triangular sections, one orange and the other white, or one red and the other white, except that where such colours merge with the background other conspicuous colours shall be used.
- (d) Flags used to mark mobile obstacles shall—
 - (1) not be less than 900 mm by 900 mm; and
 - (2) consist of a chequered pattern—
 - (i) each square having sides of not less than 300 mm; and
 - (ii) the colours of each square contrasting with each other and with the background against which they will be seen; and
 - (iii) coloured orange and white, or red and white, except where such colours merge with the background.

B.7 Use of obstacle lights

- (a) Where an obstacle is required to be lighted, it shall be by low-, medium-, or high-intensity obstacle lights, or a combination of such lights.
- (b) Light intensity shall be such that the hazard presented by the obstacle they mark is not increased.
- (c) Where the use of low-intensity obstacle lights would be inadequate or an early special warning is required, then medium or high-intensity obstacle lights shall be used.
- (d) Medium-intensity obstacle lights shall be used, either alone or in combination with low-intensity obstacle lights, where the obstacle is extensive or its height is greater than 45 m.
- (e) High-intensity obstacle lights are intended for day use as well as night use.
- (f) High-intensity obstacle lights shall be used to indicate the presence of an obstacle, if its height exceeds 150 m; or

B.8 Location of obstacle lights

- (a) Where lighting is required, at least one obstacle light shall be located at the top of the obstacle except in the case of a chimney type structure where the top lights shall be placed sufficiently below the top so as to minimise contamination by emissions.
- (b) Where the top of an obstacle is more than 45 m above the level of the surrounding ground, lights shall be provided at intermediate levels that—
- (1) shall be spaced as equally as practicable between the top light and ground level; and
 - (2) if low-intensity or medium-intensity lights are used, are spaced no more than 45 m apart.
- (c) Where high-intensity obstacle lights are used on an obstacle the lights shall be spaced no more than 105 m apart.
- (d) The number and arrangement of lights at each level to be marked shall be such that the obstacle is marked from every angle in azimuth.
- (e) Where a light on an obstacle is shielded in any direction by another object, an additional or substitute light shall be provided on the obstacle in such a way as to retain its general definition.
- (f) The top light shall be placed—
- (1) to indicate the points or edges of the obstacle that are highest in relation to the obstacle limitation surface; and
 - (2) to indicate the points or edges of the obstacle that are highest in relation to sea level; and
 - (3) in the case of a chimney type structure, between 1500 mm and 3000 mm below the top (See Figs B.2 and B.3); and
 - (4) in the case of a guyed tower or antenna that should have a high intensity obstacle light at the top but where it is impracticable to do so, at the highest practicable point, and a medium-intensity obstacle light showing white mounted on the top.
- (g) An extensive obstacle or a group of closely spaced obstacles shall—
- (1) display top lights on the points or edges of the obstacles highest in relation to the obstacle limitation surface, so as to indicate the general definition and extent of the obstacles; and
 - (2) if two or more edges are of the same height, display lights on the edge nearest the landing area; and
 - (3) where low intensity lights are required, be spaced no more than 45 m apart; and
 - (4) where medium-intensity lights are required, be spaced no more than 90 m apart.

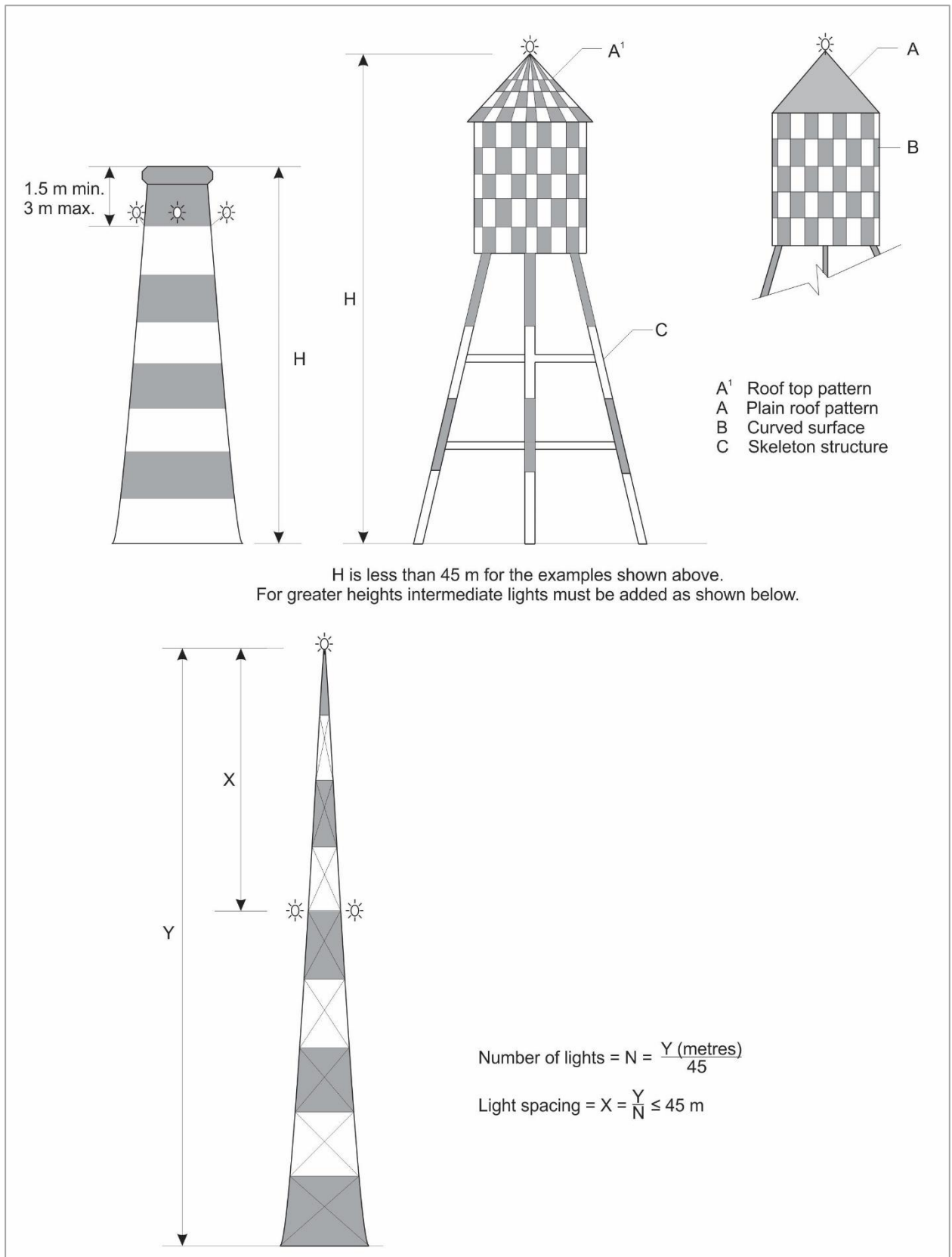

Figure B.2 – Examples of marking and lighting of tall structures

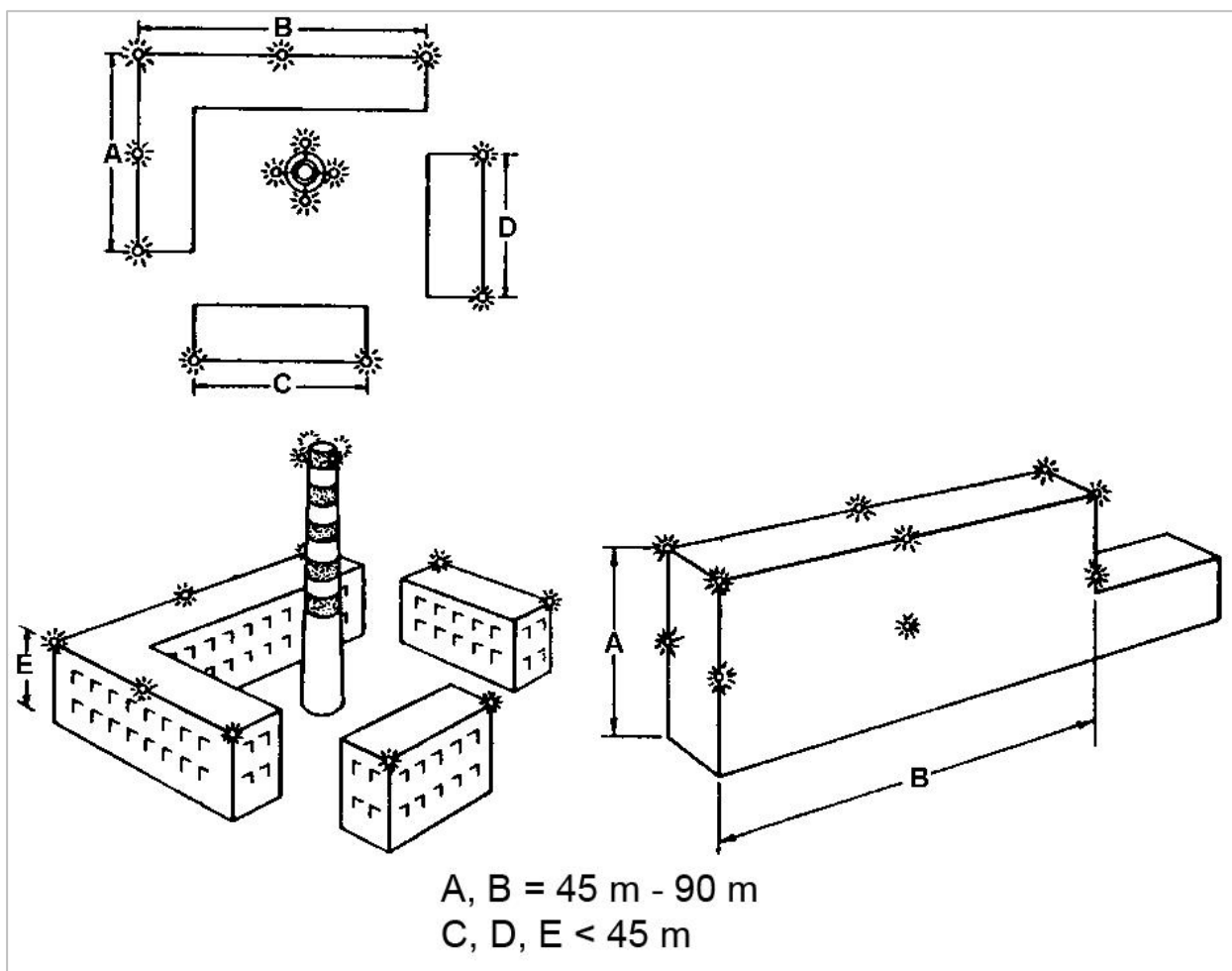

Figure B.3 – Lighting of buildings

B.9 Low-intensity obstacle light characteristics

- (a) A low-intensity obstacle light on a fixed obstacle shall be a fixed red light having an intensity that is—
- (1) conspicuous in the surroundings in which it is placed; and
 - (2) not less than 10 cd of red light.
- (b) A low intensity obstacle light on a mobile obstacle shall—
- (1) be yellow or, if yellow is not suitable, red; and
 - (2) flash at a frequency between 60 and 90 per minute; and
 - (3) have an effective intensity not less than 40 cd of yellow or red light.

B.10 Medium-intensity obstacle light characteristics

A medium-intensity obstacle light shall—

- (1) be red except when used in conjunction with a high-intensity obstacle light, in which case it shall be white; and
- (2) flash at a frequency between 20 and 60 per minute; and
- (3) have an effective intensity of not less than 1600 cd of red light.

B.11 High-intensity obstacle light characteristics

A high-intensity obstacle light shall—

- (1) be white; and
- (2) flash simultaneously at a rate between 40 and 60 per minute; and
- (3) except when located on a tower supporting overhead lines, have an effective intensity that is variable and dependent on the background luminance as follows:

Background luminance	Effective intensity
above 500 cd/m ²	200 000 cd minimum
50 to 500 cd/m ²	20 000 cd ± 25%
less than 50 cd/m ²	2000 cd ± 25%

Appendix C — Shielding

- (a) An object that is determined by the Director to be a hazard in navigable airspace may not be required to be marked or lighted if the Director considers the object to be shielded.
- (b) An object that is a lower height than another object—
- (1) already considered to be a hazard in navigable airspace; and
 - (2) that is marked by standard obstacle marking or lighting—
- may be considered to be shielded by the other object.
- (c) An aeronautical study may be required to determine whether an object that penetrates an obstacle limitation surface is shielded.
- (d) A shielding object shall be permanent.
- (e) For the purposes of paragraph (c) an object may be classed as permanent only if, when taking the longest view possible, there is no prospect of removal being practicable, possible, or justifiable, regardless of how the pattern, type, or density of air operations might change.
- (f) Where the obstacle being shielded lies within the approach or take-off surface, or the transitional side or inner horizontal surface, it shall meet the criteria illustrated in figures C.1 and C.2 in relation to the shielding object.
- (g) Where the obstacle lies outside of the areas referred to in paragraph (e) it may be considered shielded if located within 600 m of the shielding object.

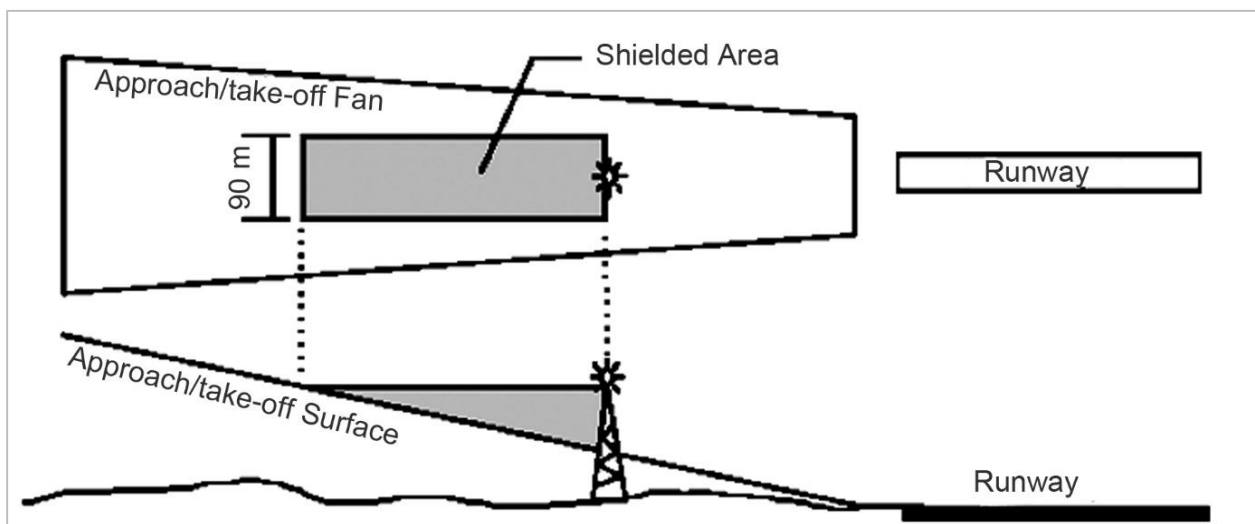

Figure C.1 – Shielding Approach and Take-off Surface

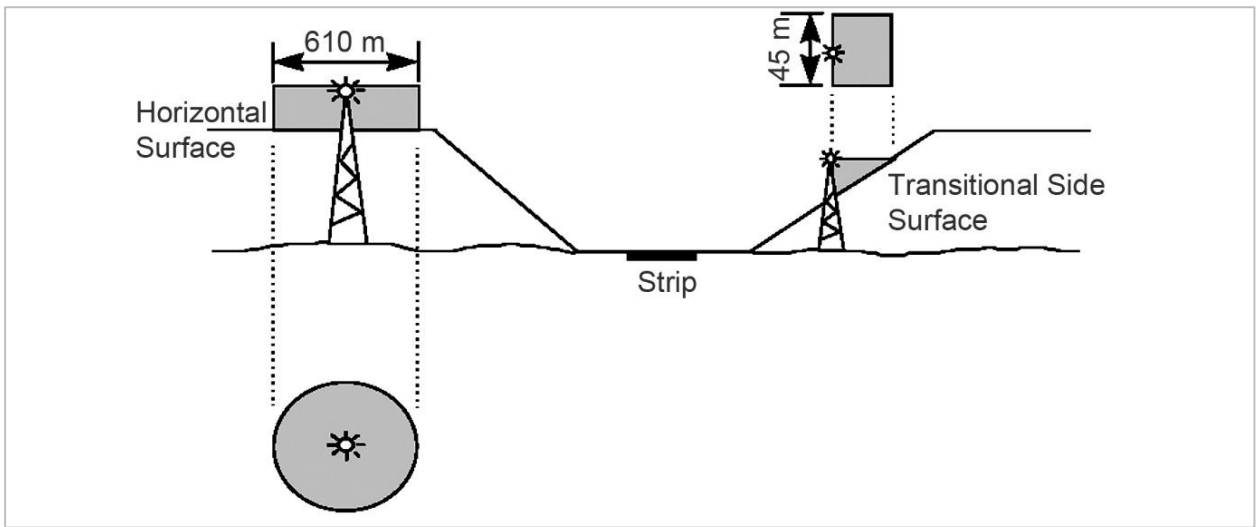

Figure C.2. – Shielding Transitional and Horizontal Surfaces

--oOo--